



*One for all . . .*

## **MACH II Shootbolt Espagnolette**

TECHNOLOGY IN MOTION

---

# MULTI TREND

**Fittings that,  
fulfil all your window requirements!**

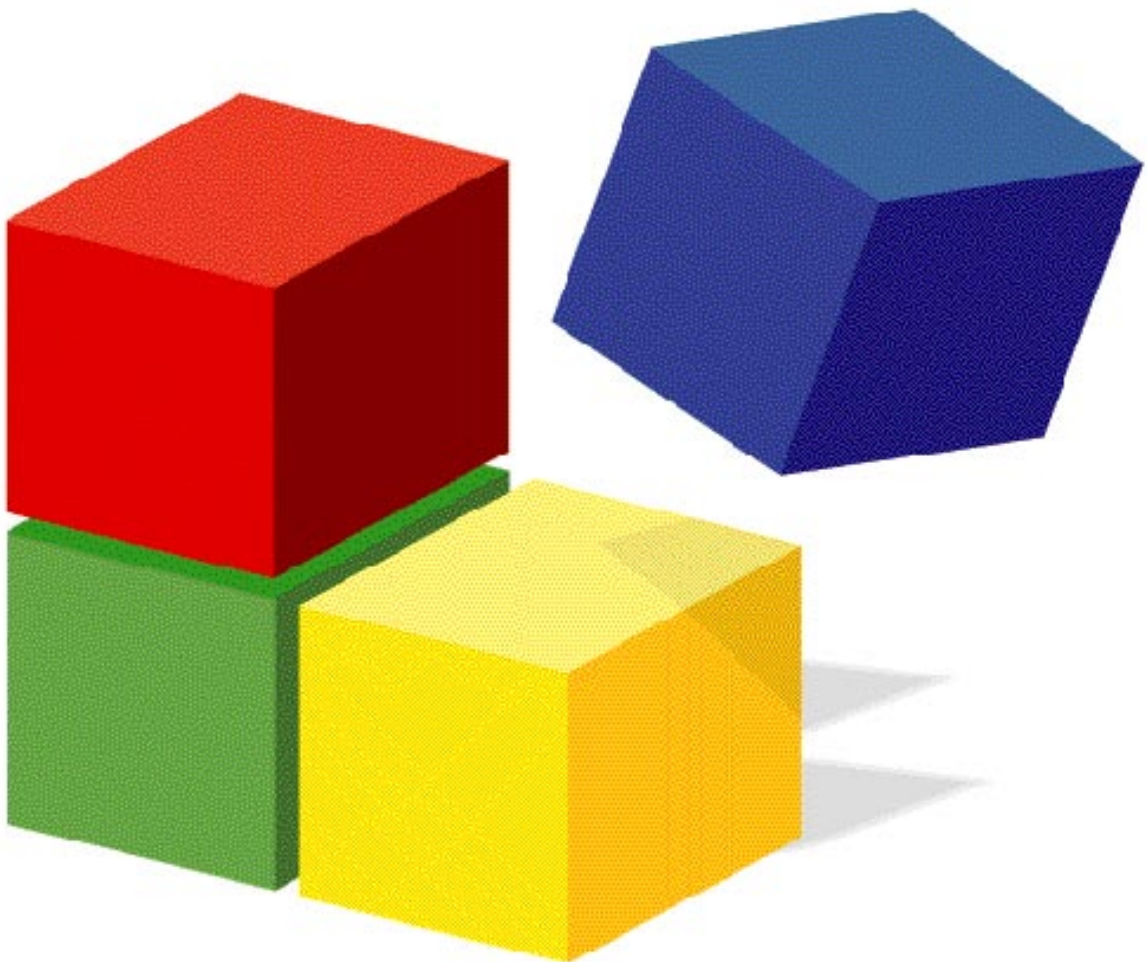

## **MACH II - *One for all . . .***

The technology behind our fittings allows all of these possibilities in one single programme.  
Simply: *one for all . . .*

# - One for all . . .

---

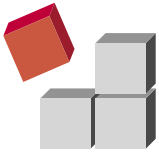

## **SECURE**

You want secure windows . . .

- that have central locking cams
- that have a mushroom and shootbolt corner combination
- that exceed the requirements of BS7950:1997

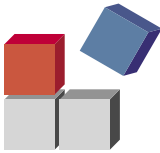

## **FUNCTIONAL**

You want functional windows . . .

- that are easy to operate
- that are simple to adjust
- that will make your windows stand out from the rest

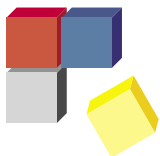

## **FAST**

You want fast and efficient fabrication . . .

- of the striker plates onto the frame
- with fittings that do not require cropping to size
- that clip into the eurogroove

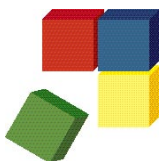

## **COMPATIBLE**

You want fittings that . . .

- fully locate into the eurogroove
- are manufactured specifically for your profile system
- that are reliable in use



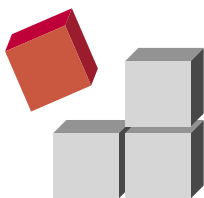

# Secure

The issue of a window's burglar resistance gains more prominence every day. You need to be able to produce windows that have build tolerances so that they perform as required

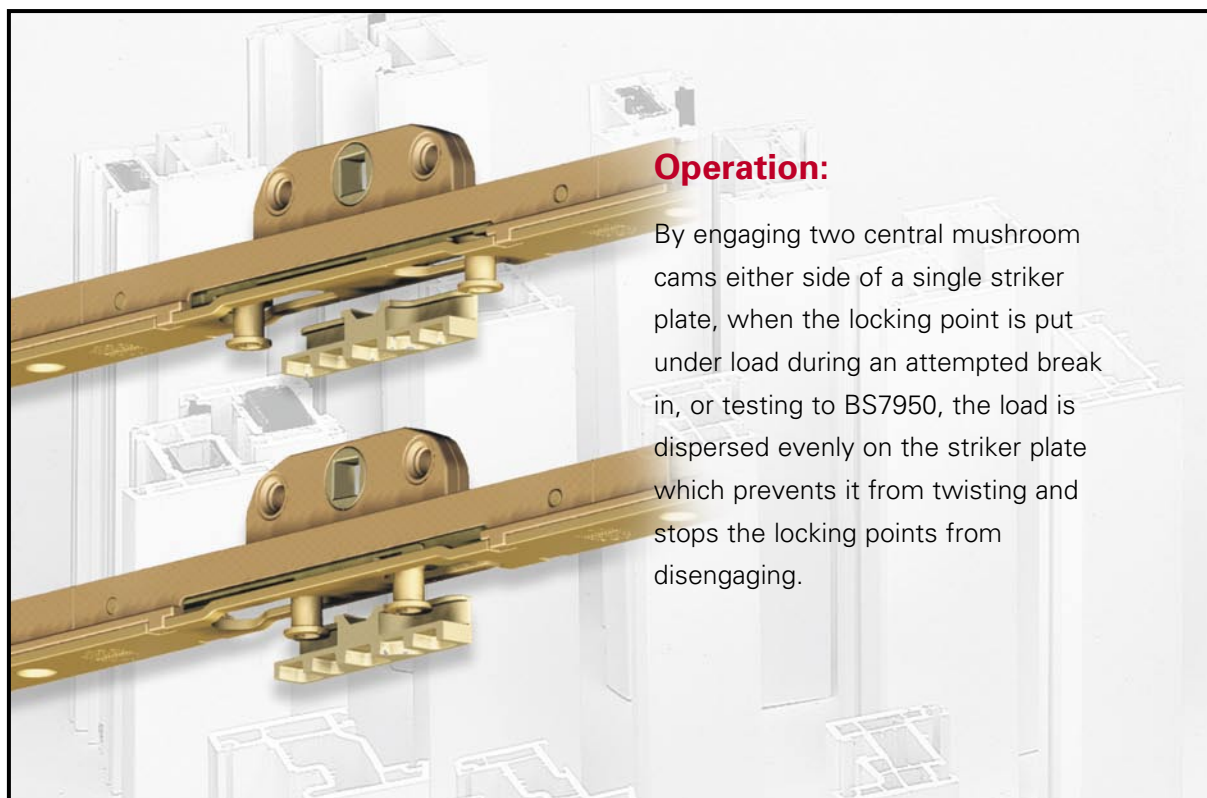

## Operation:

By engaging two central mushroom cams either side of a single striker plate, when the locking point is put under load during an attempted break in, or testing to BS7950, the load is dispersed evenly on the striker plate which prevents it from twisting and stops the locking points from disengaging.

## MACH II Shootbolt Espagnolette . . .

. . . the most advanced way of securing a window.  
. . . creates satisfied customers putting you one step ahead of the competition.



- Central mushroom cams tested to 8,7Kn, almost three times more than the requirements of BS7950:1997.
- MACH II meets all the requirements of BS7950:1997.
- Two central mushroom cams.
- Adjustable shootbolt throw 10-13 mm
- Interlocking shootbolt and mushroom strikes.
- Steel cover plate.

# The MACH II shootbolt espagnolette . . .

. . . has been designed to give years of customer satisfaction through a reliable function



- Secure steel cover plate.
- Improved screw positions so that they pick up the reinforcing.
- Small routing detail maintains strength in the profile.
- 19 mm cam travel ensures maximum engagement into the striker plate.
- Sintered steel spindle follower and drive wheels ensure strength and durability.
- 500 hours salt spray corrosion resistance.
- Manufactured under BS ISO 9001.

Stabilizing plates (only required on some profile systems) help to increase the strength of the corners.



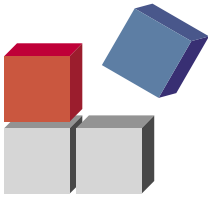

# Functional

The window fittings will enable you to produce good looking windows whilst enhancing the overall performance. Your customers will know that they are getting the best available window technology.



## Double Side Hung Casement Window with Floating Mullion

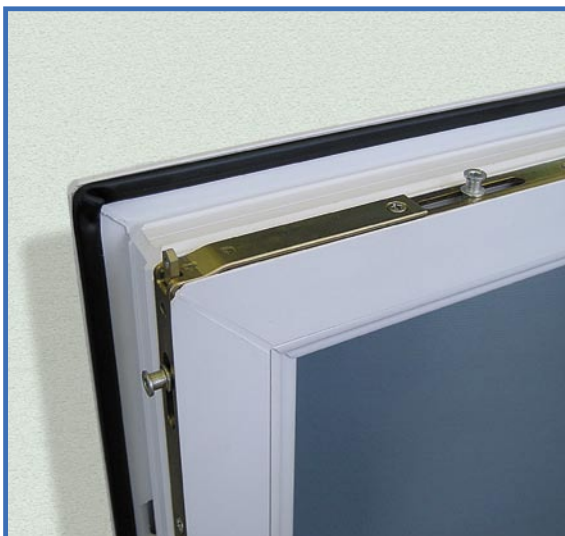

The MACH II shootbolt espagnolette has been developed with versatility in mind. This easily enables the production of a wide range of window styles.

**The MACH II enables the production of the following windows styles:**

- Double side hung casement window
- Tall top hung windows with round the corner locking
- Low handle height for disabled access or hard to reach windows



## Striker plates

All MACO striker plates incorporate a night vent position to allow airflow into occupied rooms. For security reasons it is not recommended that windows are left in the night vent position when the house is unoccupied.

A slimline striker plate design results in optically pleasing sight lines when the window is open.

## Simple and easy

Windows fitted with the MACH II shootbolt espagnolette are simple and easy to operate. The smooth operation is achieved by the use of adjustable mushroom cams to close the window. The end shootbolts are passive and only come into contact with the shootbolt strike when the windows is attacked.

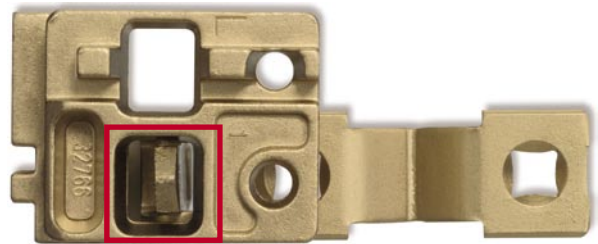

## Adjustable

All mushroom cams are adjustable for compression by plus or minus 1 mm. This enables the weather performance capabilities to be maintained for many years to come.

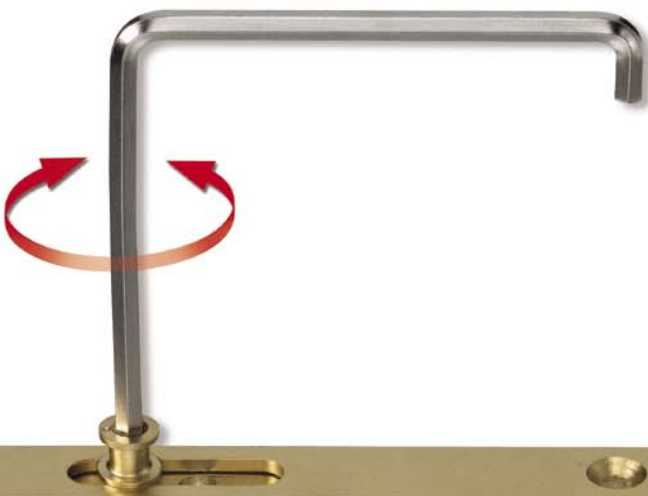

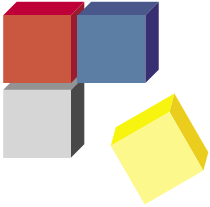

# Fast

In an ever changing market new window fabrication methods are constantly being developed. As methods improve, the installation of the hardware has to be able to keep up with the pace change.

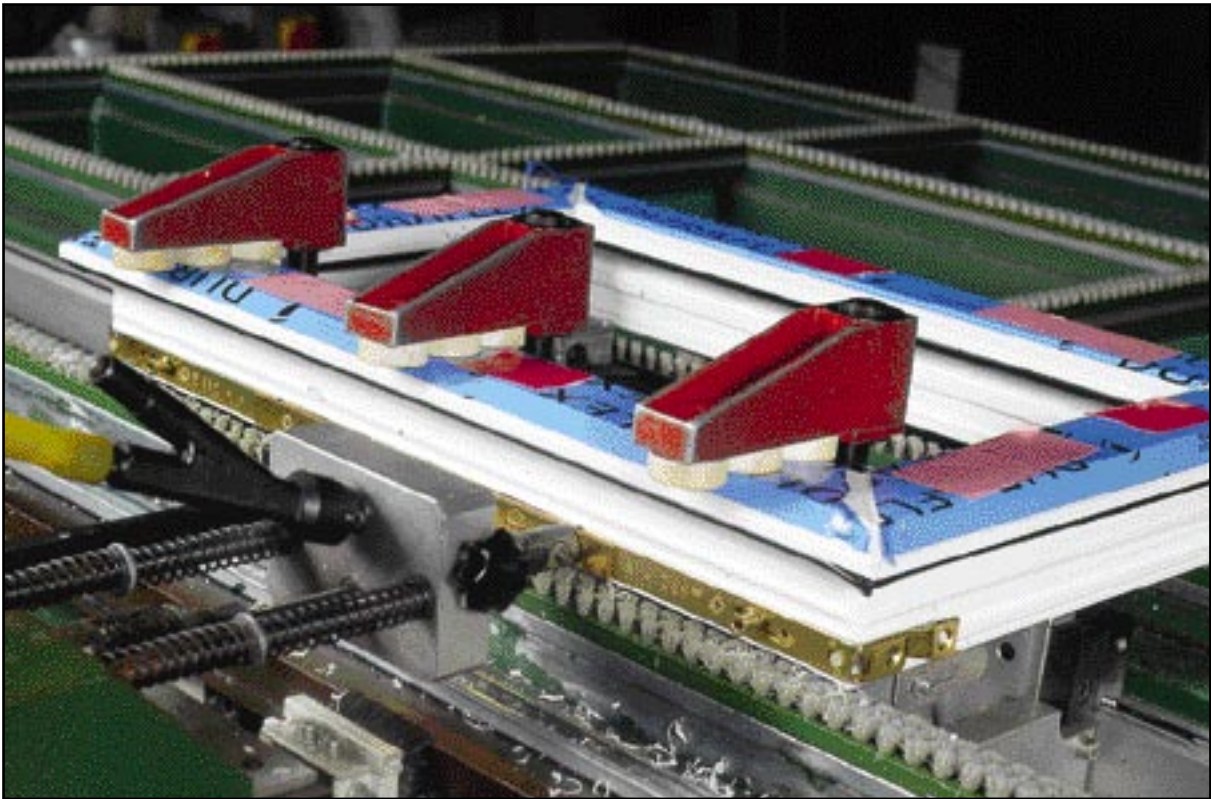

## „Click-Fix“ – Eurogroove clips

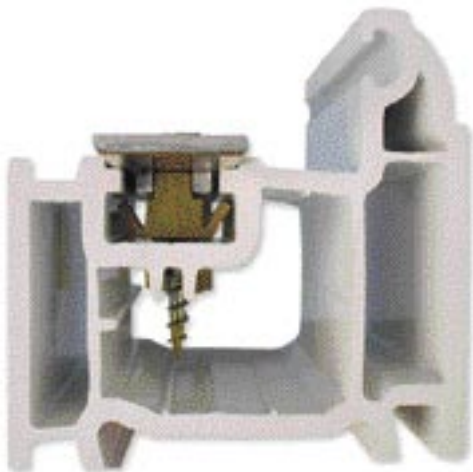

### Click-Fix:

- Hold extensions in the eurogroove
- Speeds up production
- No special components required
- Helps automatic assembly machines
- Helps when assembling by hand



## Rapid-Fix - non crop extensions

- No need to crop extensions to size
- 50 mm adjustment per extension
- Size increases in 100 mm increments
- 9 Rapid-Fix extensions for SRS 500 - 1400 mm

The MACH II shootbolt espagnolettes are also available with Std-Fix croppable extensions. The Std-Fix version has all the

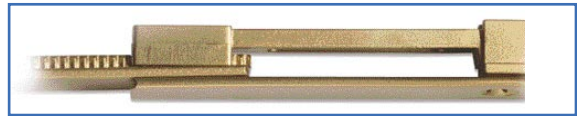

*Rapid-Fix extension partially enclosed*

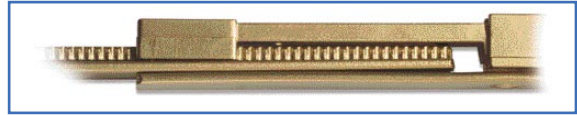

*Rapid-Fix extension fully enclosed*

features of the Rapid-Fix but requires the extensions to be cut to size with a pneumatic cropping machine.



*Striker Plate Locating Jig*

## Rapid assembly of striker plates

- The mushroom and shootbolt striker plates combine to form the end strikers that are located into the corners of the frame
- A mushroom striker plate is located in the centre of the frame
- For faster assembly a locating jig is available for positioning the centre mushroom strike

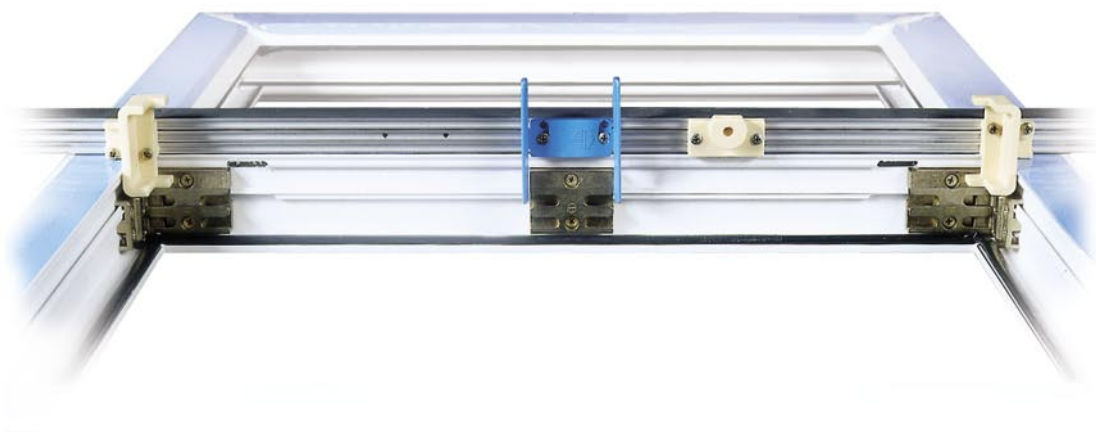

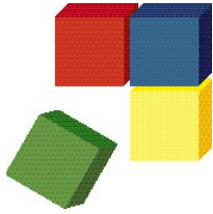

# Compatible

You need to ensure that your fittings will operate smoothly and are fully compatible with your window system

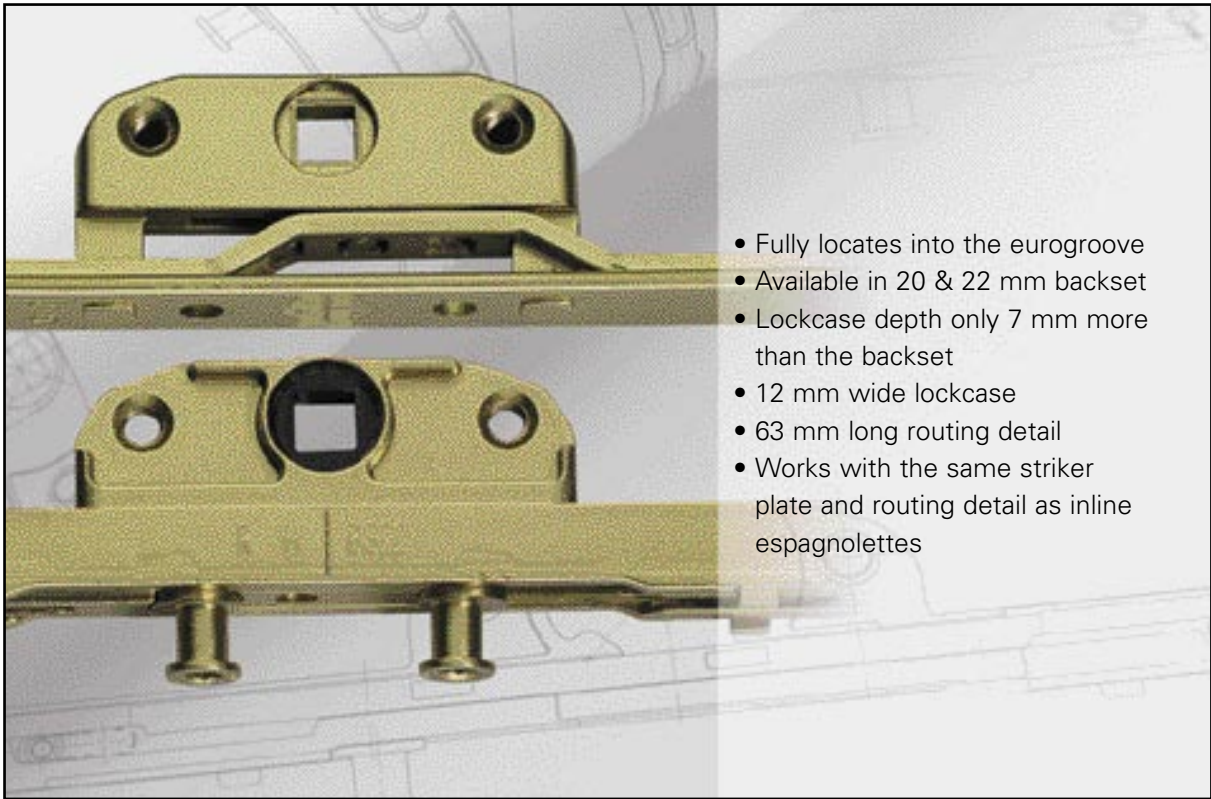

- Fully locates into the eurogroove
- Available in 20 & 22 mm backset
- Lockcase depth only 7 mm more than the backset
- 12 mm wide lockcase
- 63 mm long routing detail
- Works with the same striker plate and routing detail as inline espagnolettes

The MACH II shootbolt espagnolette has been designed for profile systems with a eurogroove depth of 9 mm.

This ensures that the MACH II lockcase is fully supported within the eurogroove and that the connecting shoes are supported by the base of the profile, making the assembly quicker, simpler and more secure. With a lockcase width of

12 mm and an overall depth of only 7 mm more than the backset, this virtually eliminates the possibility of the lockcase breacking into the glazing area.

Different backsets (20 & 22 mm) coupled with two mushroom heights (7.7 & 9.0 mm) along with bespoke striker plates ensures that correct manufacturing tolerances are achieved.

## Dedicated striker plates are designed to suit individual profile systems

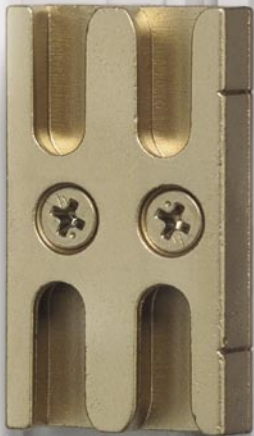

All MACO striker plates are developed in conjunction with the systems extrusion companies, this guarantees that they are an exact fit.

By developing our striker plates this way we are able to maximize the strength and security of the windows as we can position the screw fixings so that they pick up screw ports and reinforcing.

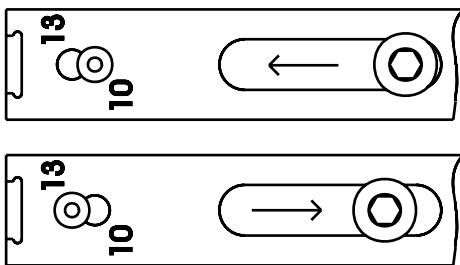
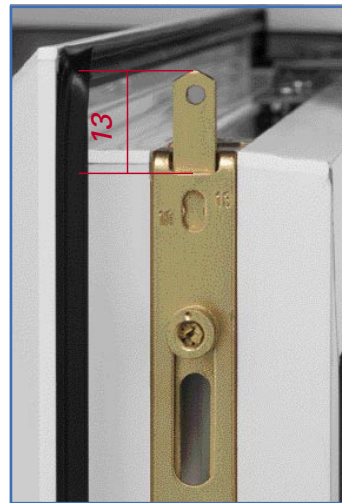

To adjust the shootbolt throw 10 to 13 mm, move the mushroom cam so that the plastic pin locates into the desired position. This should be done before either cropping the extension to size, or locating the extension into the rapid-fix drive gear.



[www.maco-europe.com](http://www.maco-europe.com)

Order No. 49682 — Date: January 2002

**MAYER & CO.  
BESCHLÄGE GMBH**

A-5020 Salzburg  
Alpenstraße 173  
Tel.: +43 (0)662 6196-0  
Fax: +43 (0)662 6196-101  
e-mail: [maco@maco.at](mailto:maco@maco.at)  
<http://www.maco.at>

**MACO-BESCHLÄGE  
GESELLSCHAFT M.B.H.**

D-94508 Schöllnach  
Haidhof 3  
Tel.: +49 (0)9903 9323-0  
Fax: +49 (0)9903 9323-60  
e-mail: [d-maco@maco.de](mailto:d-maco@maco.de)  
<http://www.maco.de>

**MACO DOOR & WINDOW  
HARDWARE (U.K.) LTD**

Eurolink Industrial Centre, Castle  
Road, Sittingbourne Kent, ME10 3LY  
Tel.: +44 (0)1795 433900  
Fax: +44 (0)1795 433901  
e-mail: [maco@macouk.net](mailto:maco@macouk.net)  
<http://www.macouk.net>

**MAICO SRL**

I-39015 S. Leonardo i. P.  
Zona Artigianale 15  
Tel.: +39 (0)473 651200  
Fax: +39 (0)473 651300  
e-mail: [maico@maico.com](mailto:maico@maico.com)  
<http://www.maico.com>

**MACO-BESCHLÄGE B.V.**

NL-7021 BN Zelhem  
Stikkenweg 60  
Tel.: +31 (0)314 622627  
Fax: +31 (0)314 623649  
e-mail: [info@maco-nl.nl](mailto:info@maco-nl.nl)  
<http://www.maco-europe.com>

**MACO POLSKA  
SP. Z O.O.**

PL 44-137 Czekanów k/Gliwicz  
Ul. Gliwicka 1a  
Tel.: +48 (0)32 3050904  
Fax: +48 (0)32 3050901  
e-mail: [maco@demo.pl](mailto:maco@demo.pl)  
<http://www.maco-europe.com>